

SPARE PARTS LIST

Tremix BFP, Honda



TREMIX®

SPARE PART LIST

Date 0603

TREMIX BFP, Honda

Contents

Page 4-5 Bull Float

Page 6-7 Handle

SPARE PART LIST

TREMIX BFP, Honda

Date 0603

Pos	NO	DENOMINATION	Qty	
1		Washer	DIN 7349 6,4x17x3 fxb	2
2		Locking washer	Nordlock M5	4
3		Locking washer	Nordlock M8	1
4		Locking washer	Nordlock M10	1
5		Locking washer	Nordlock M6 fzb	13
6		Nut	M6M 6	8
7		Nut	M6M 8	1
8		Nut	M6M 10	1
9		Screw	M6S 5x16 fzb	4
10		Screw	M6S 6x30	1
11		Screw	M6S 6x10 fzb	2
12		Screw	M6S 6x12 fzb	2
13		Screw	M6S 8x18 fzb	1
14	000141	Ball bearing		2
15	000322	Radial sealing		1
16	000447	Retaining ring for shaft		2
17	000539	O-ring		1
18	002127	Shock absorber		4
19	002257	Shock absorber		6
20	002259	Handle tube		2
21	002633	Kill switch		1
22	002741	Spring		1
23	002829	Petrol engine		1
24	002830	Tool clips		4
25	022021	Revolving device cpl		1
26	033106	Bullfloat profile		1
27	033107	Handle		1
28	033108	Fork		1
29	047528	Lid		1
30	047529	Vibrator shaft		1
31	047627	Unbalance		1
32	048071	Throttle control		1
33	049096	Connection nut		1
34	049097	Bracket plate		1
35	049098	Throttle wire		1

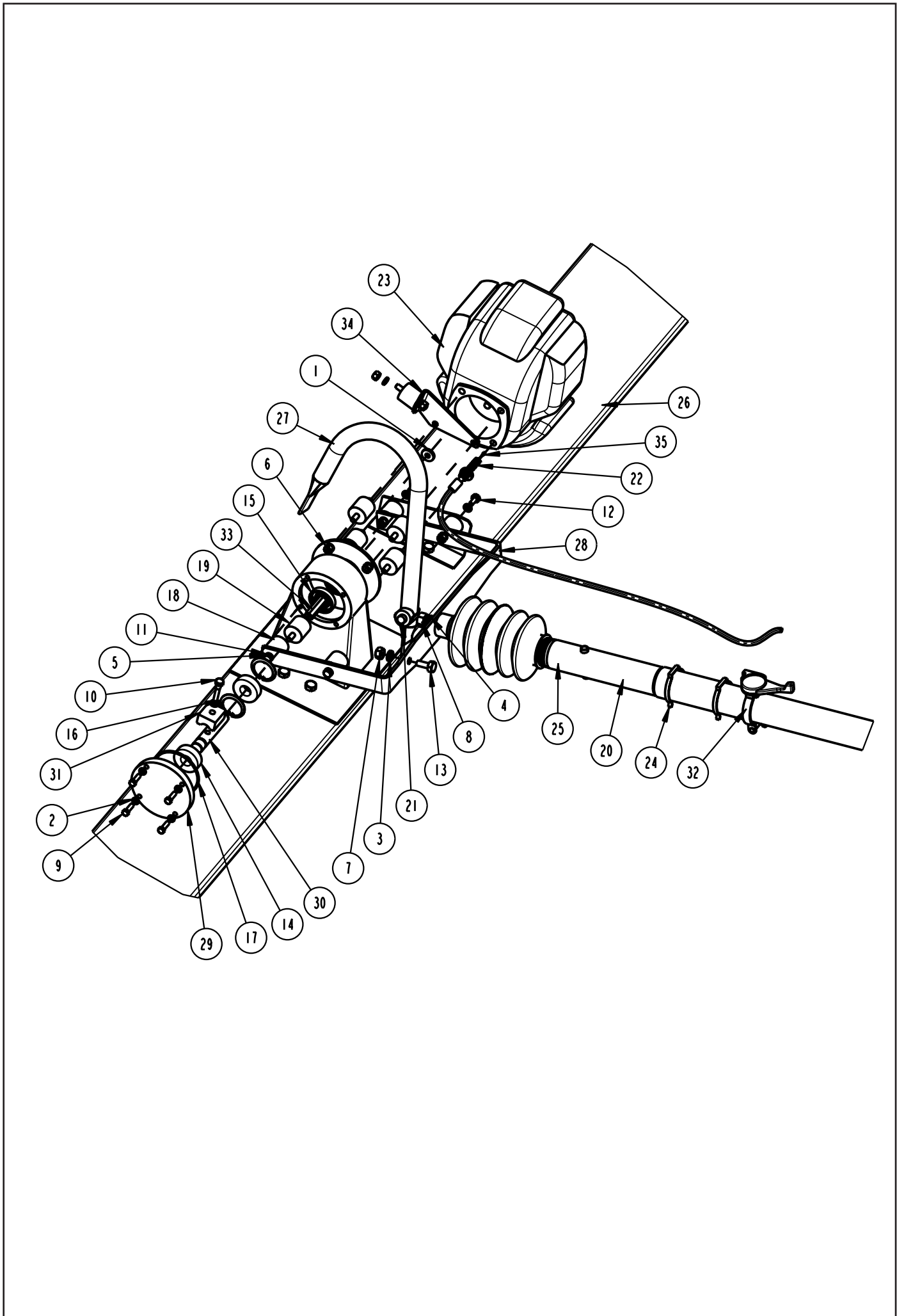

SPARE PART LIST

TREMIX BFP, Honda

Date 0603

Pos	NO	DENOMINATION	Qty	
1		Washer	BRB 10.5x21x2 fzb	2
2		Cylindric bolt	HCB 8x22 fzb	1
3		Cylindric pin	CP 8x40 fzb	1
4		Spring pin	FRP 3x40	1
5		Split pin	SP 3.2x40	1
6		Screw	M6S 10x16 fzb	1
7		Screw	M6S 10x45 fzb	1
8		Screw	M6S 8x45 fzb	1
9		Special washer	10x26x2 9805	1
10	000124	Flange bearing		2
11	000124	Star lock		2
12	000385	Foam washer		1
13	000385	V-ring		1
14	000450	Flange ring		2
15	002302	Clips		1
16	002681	Cable holder		1
17	047682	Shaft		1
18	047683	Ring		1
19	047684	Fork		1
20	047685	Distance		1
21	047686	Link		1
22	047687	Screw		1
23	047689	Sleeve		1
24	048035	Sleeve		1
25	586018	Locking nut		1

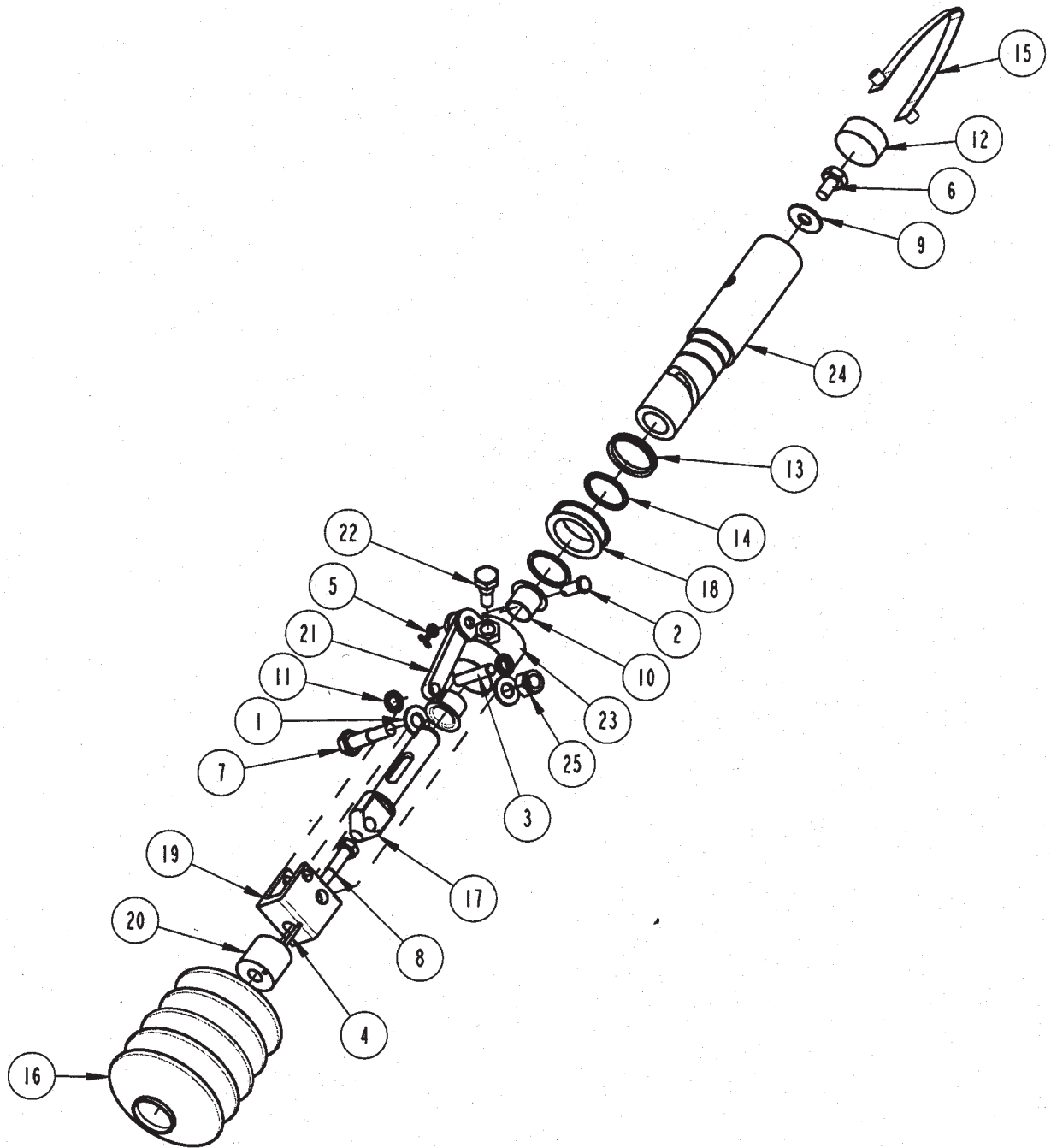

RESERVDLSBESTÄLLNING

För att undvika felleveranser vid reservdelsbeställning är det angeläget att produkttyp och tillverkningsnummer såväl som pos., antal, benämning och detaljnummer anges.

SPARE PARTS ORDERING

To prevent wrong deliveries, your orders should specify type of product, serial number as well as item No., quantity, denomination and part No.

ERSATZTEILBESTELLUNG

Um fehlerhafte Lieferungen bei Ersatzteilbestellung zu vermeiden, ist es wichtig, daß Typ und Herstellungsnummer sowie Position, Anzahl, Benennung und Teil-Nr. angegeben werden.

